

## Research on Critical Technologies of Narrow Gap SAW

HUA Ai-bing, JIAN Zhi-yong, LEI Yong

(Beijing TIME Technologies Co., LTD , Beijing, 100085, China)

**Abstract:** For critical technologies which arc bead array and seam tracking of narrow gap SAW, a new swing mechanism of conductive nozzle and a long-distance laser trace system arc designed. The combination drive of gear and rack is used for the swing mechanism, which characterized as liner control and high-precision of repeat positioning. The principle of long-distance laser tracking is that the inner groove is scanned by one laser point drove with servo motor and the groove message is real time exacted. So the distance from wire end to side wall and the length of wire extension remain constant.

**Key words:** narrow gap SAW; laser tracking; scanning

1

[1]

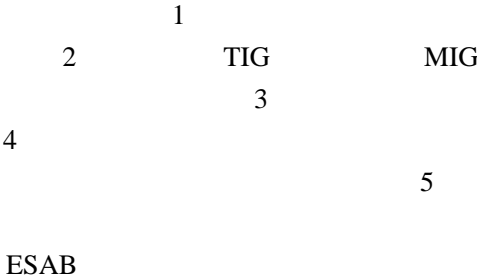

[2-5]

2



1a

1

1b

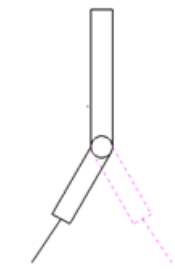

a

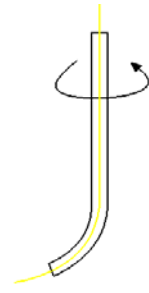

b

1

1

1

[6]

2

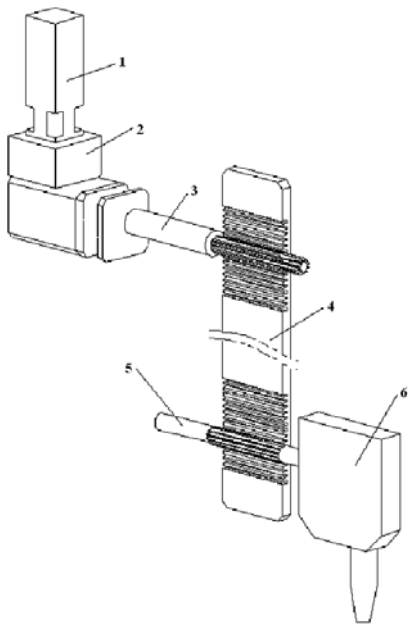

a

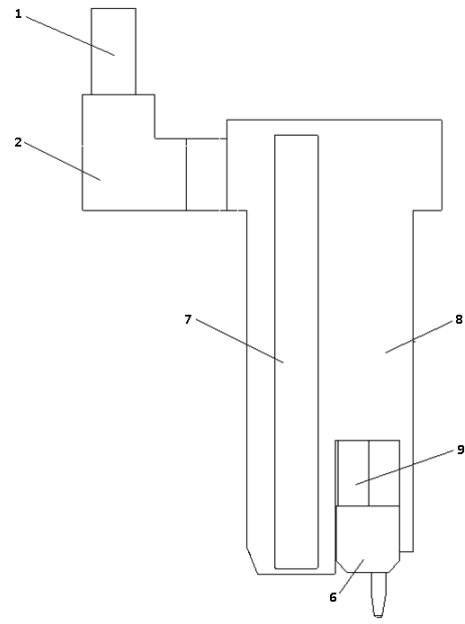

b

- 1-                      2-                      3-                      4-                      5-
- 6-                      7-                      8-                      9-
- 2                      -

2

3

350mm

3

3b

A

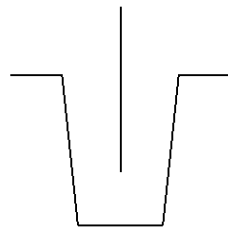

a

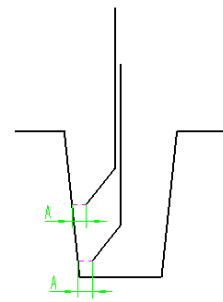

b

3

4

3

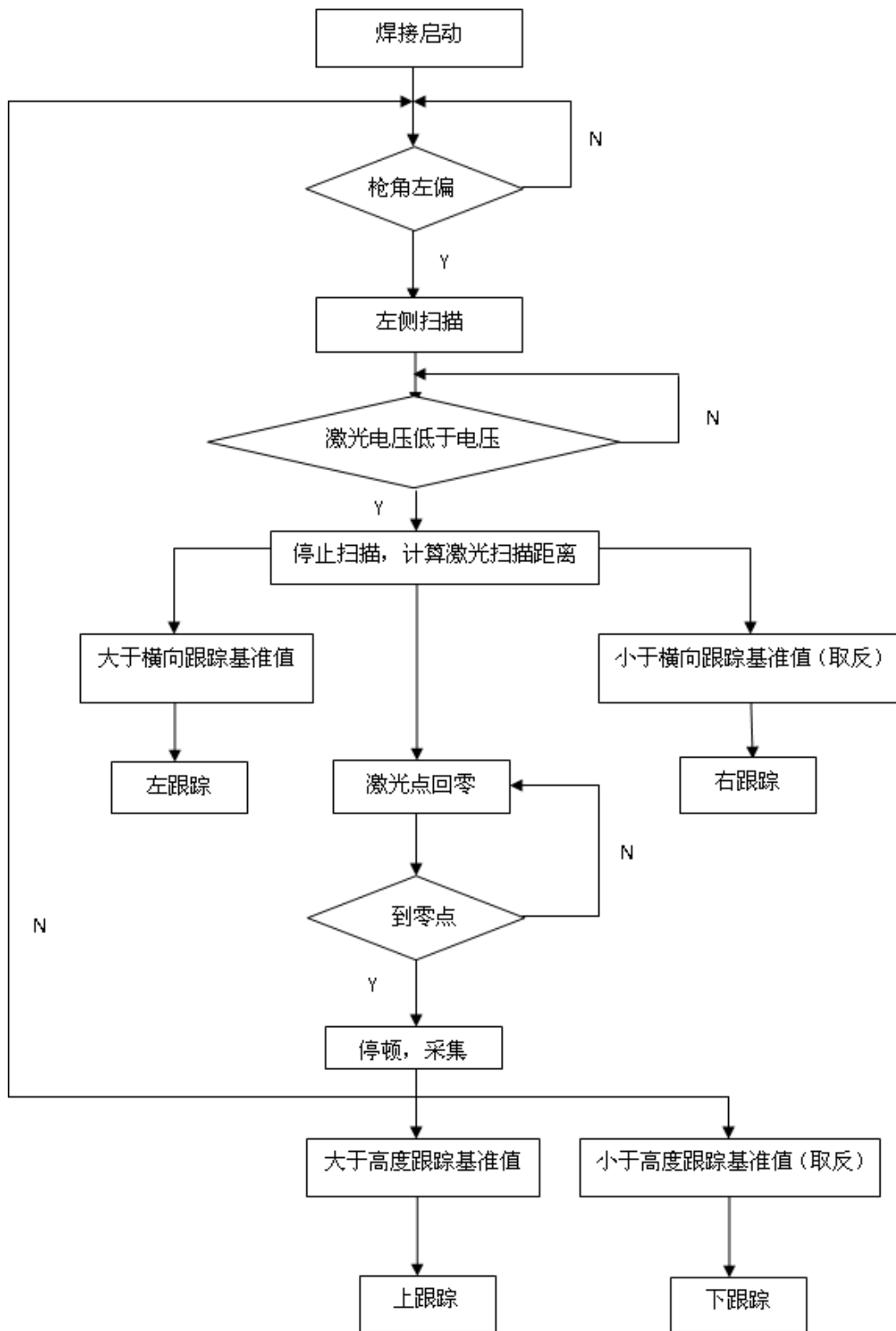

(

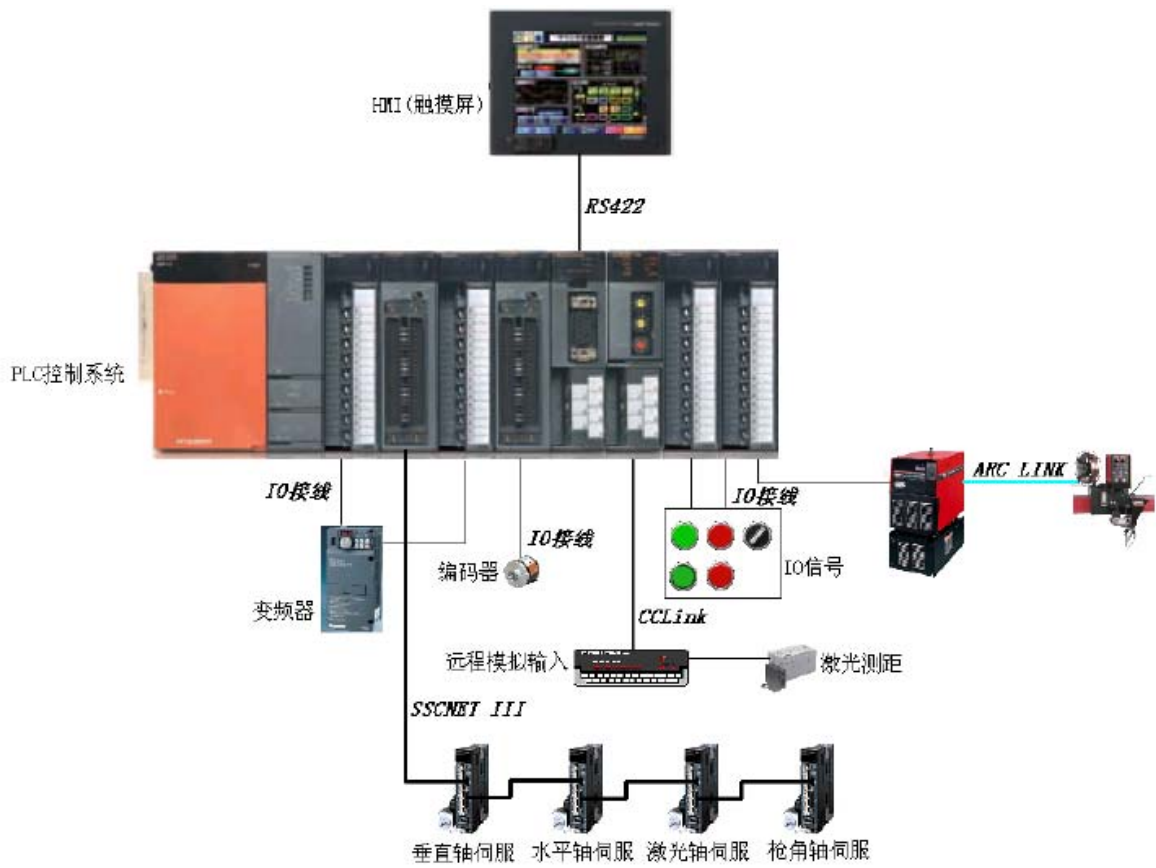

)

PLC

CCLINK

DEVICENET

5

PLC

- [1] . . . . . .2007,37(2):28-29
- [2] , .ESAB( ) . .1999(8):29-32
- [3] . -HNG . .1997(1):41-44
- [4] . . . . . .1991(1):8-9
- [5] , , . . . . . .2009(8):94-96
- [6] , , . . . . . .2010(2):16-21

1977—